

(19) **United States**

(12) **Patent Application Publication**

**Liu et al.**

(10) **Pub. No.: US 2023/0035541 A1**

(43) **Pub. Date:**

**Feb. 2, 2023**

(54) **OPTIMIZING A PROGNOSTIC-SURVEILLANCE SYSTEM TO ACHIEVE A USER-SELECTABLE FUNCTIONAL OBJECTIVE**

**Publication Classification**

(51) **Int. Cl.**  
*G06N 7/00* (2006.01)  
*G06N 5/04* (2006.01)  
*G06K 9/62* (2006.01)  
*G06K 9/00* (2006.01)

(52) **U.S. Cl.**  
 CPC ..... *G06N 7/005* (2013.01); *G06N 5/04* (2013.01); *G06K 9/6265* (2013.01); *G06K 9/6256* (2013.01); *G06K 9/6235* (2013.01); *G06K 9/00516* (2013.01); *G06K 2009/6237* (2013.01)

(71) Applicant: **Oracle International Corporation**, Redwood Shores, CA (US)

(72) Inventors: **Menglin Liu**, San Mateo, CA (US); **Richard P. Sonderegger**, Dorchester, MA (US); **Kenneth P. Baclawski**, Waltham, MA (US); **Dieter Gawlick**, Palo Alto, CA (US); **Anna Chystiakova**, Palo Alto, CA (US); **Guang C. Wang**, San Diego, CA (US); **Zhen Hua Liu**, San Mateo, CA (US); **Hariharan Balasubramanian**, Redmond, WA (US); **Kenny C. Gross**, Escondido, CA (US)

(73) Assignee: **Oracle International Corporation**, Redwood Shores, CA (US)

(21) Appl. No.: **17/386,965**

(22) Filed: **Jul. 28, 2021**

(57) **ABSTRACT**  
 The disclosed embodiments relate to a system that optimizes a prognostic-surveillance system to achieve a user-selectable functional objective. During operation, the system allows a user to select a functional objective to be optimized from a set of functional objectives for the prognostic-surveillance system. Next, the system optimizes the selected functional objective by performing Monte Carlo simulations, which vary operational parameters for the prognostic-surveillance system while the prognostic-surveillance system operates on synthesized signals, to determine optimal values for the operational parameters that optimize the selected functional objective.

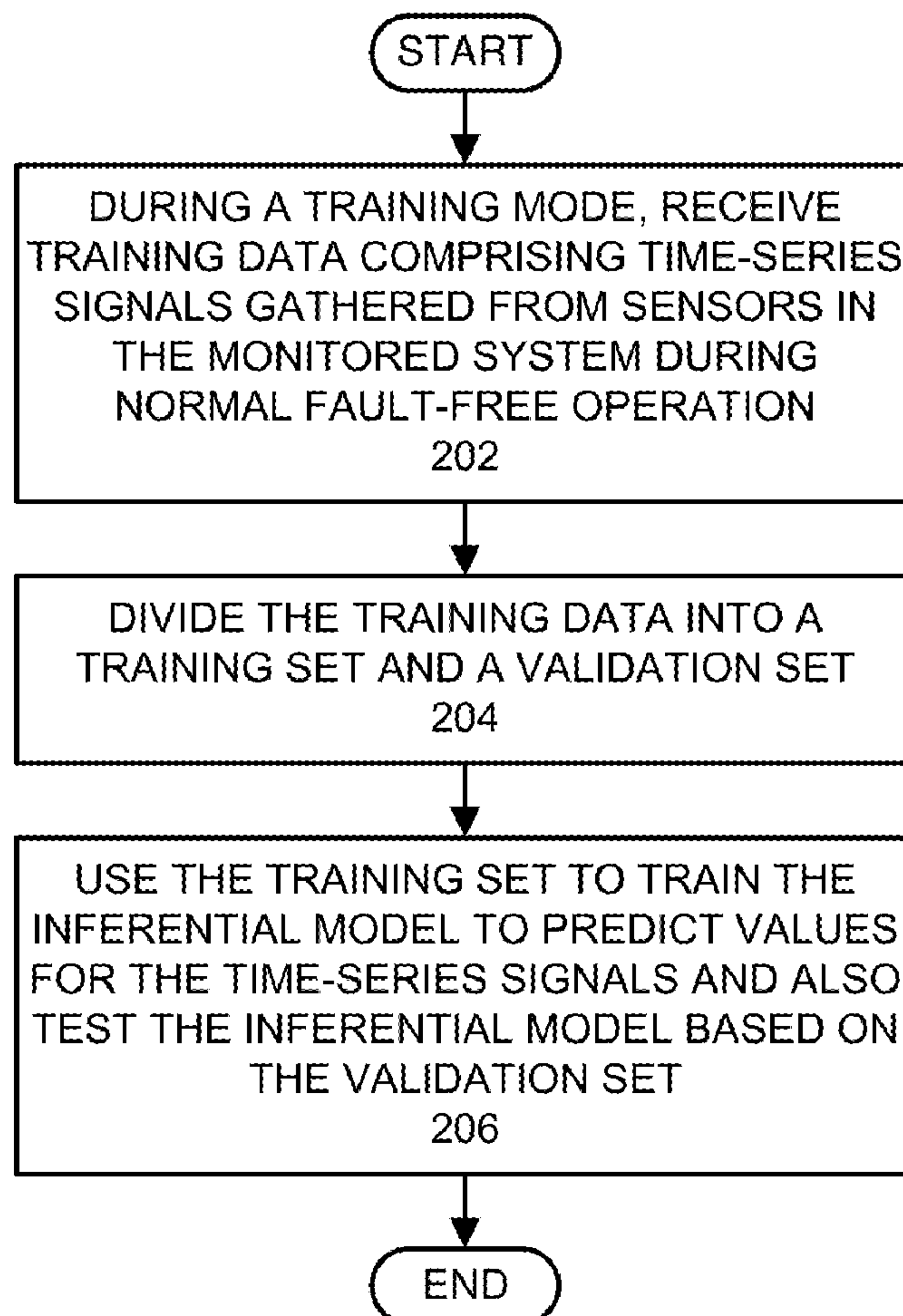

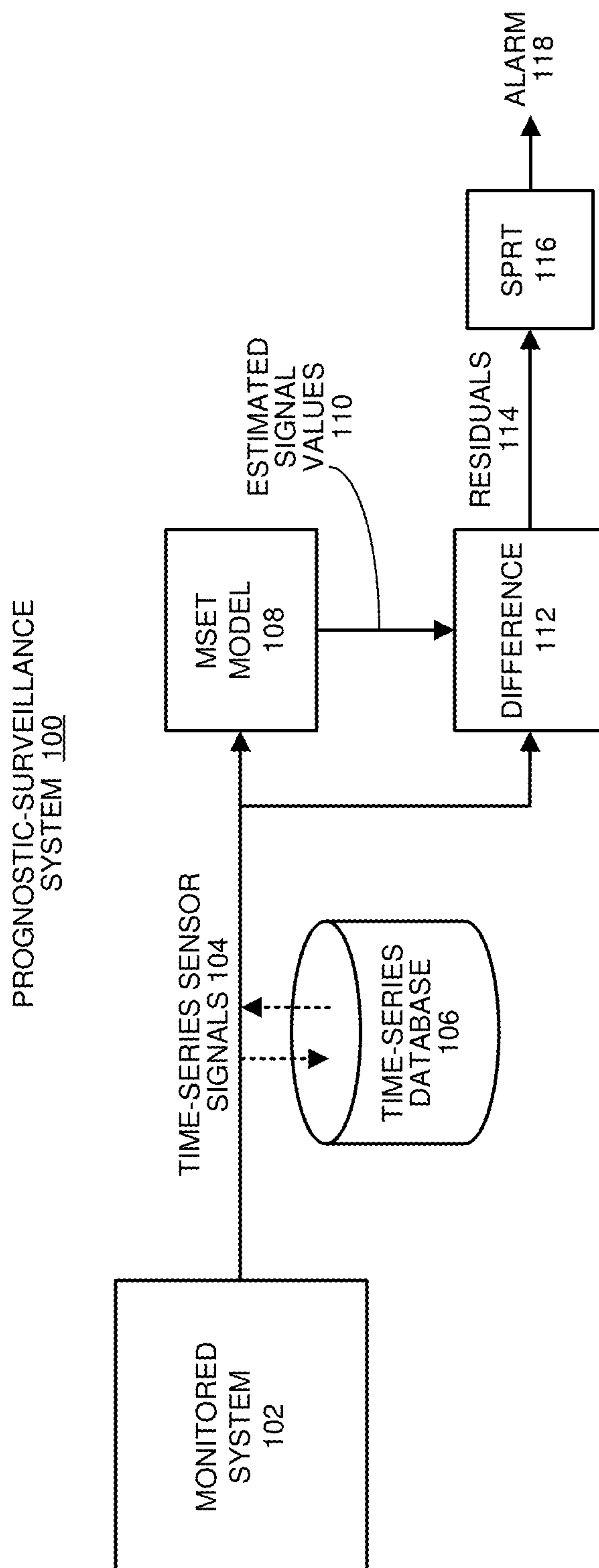
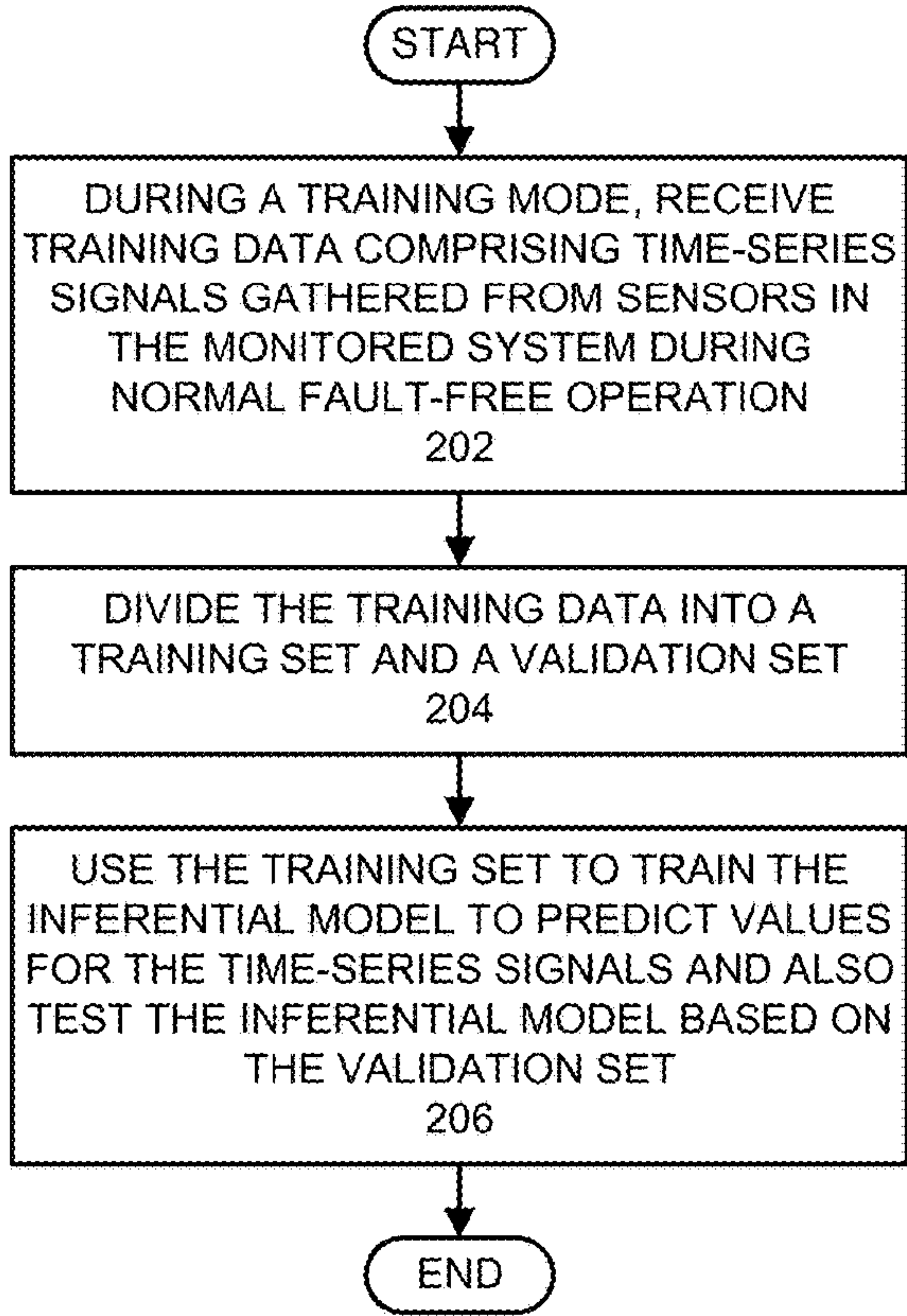
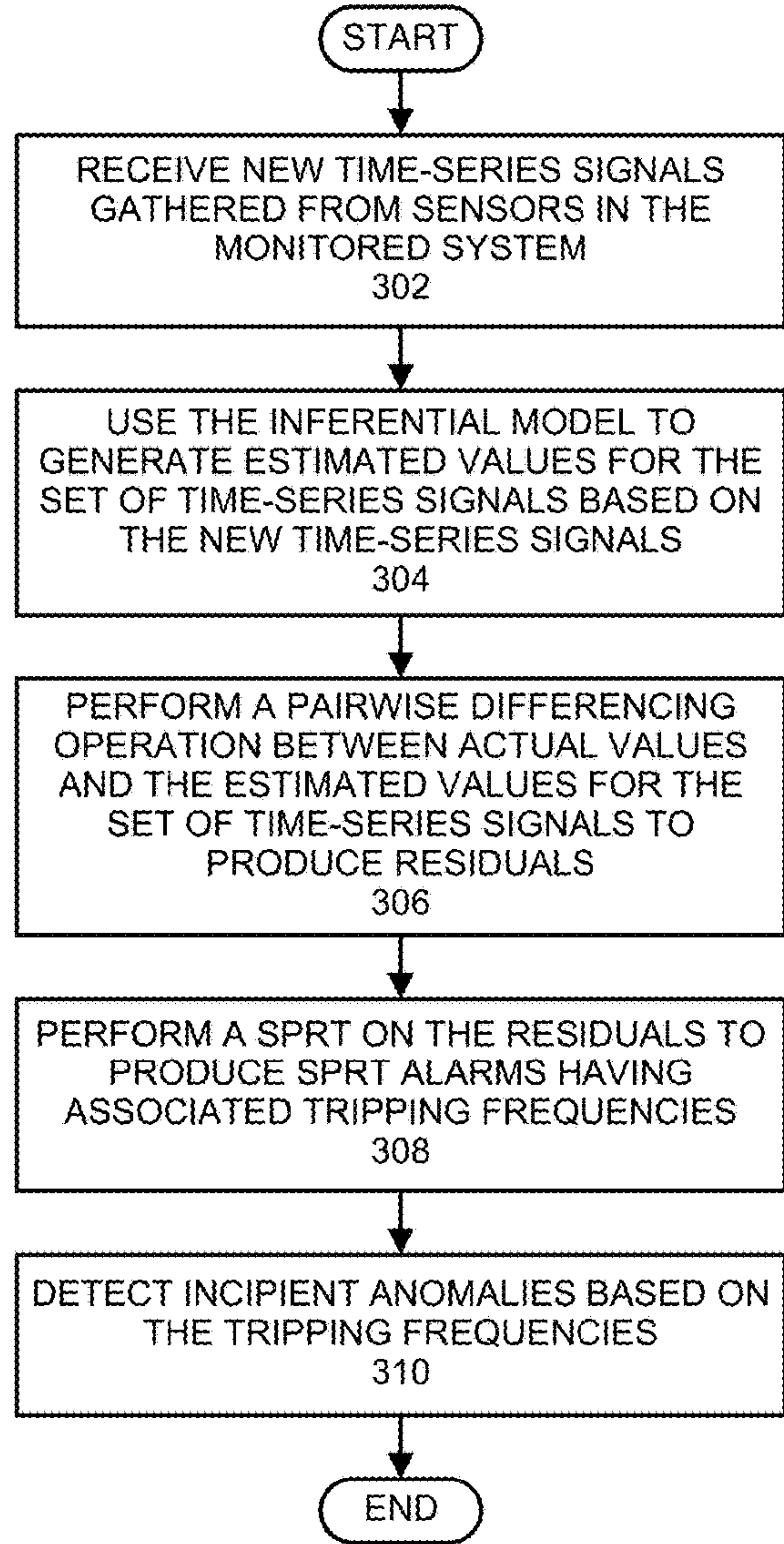

FIG. 1



**FIG. 2**



**FIG. 3**



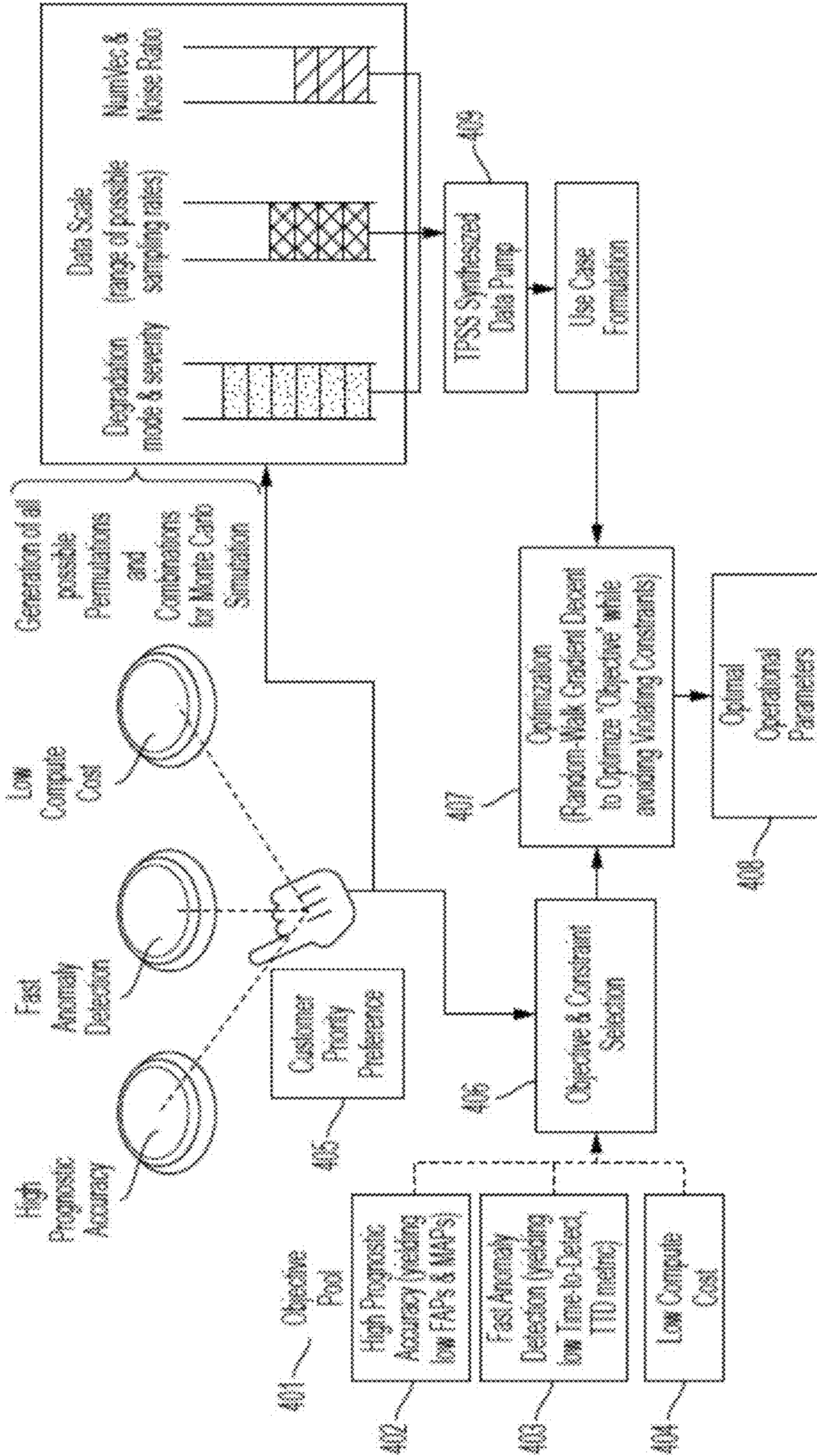

FIG. 4



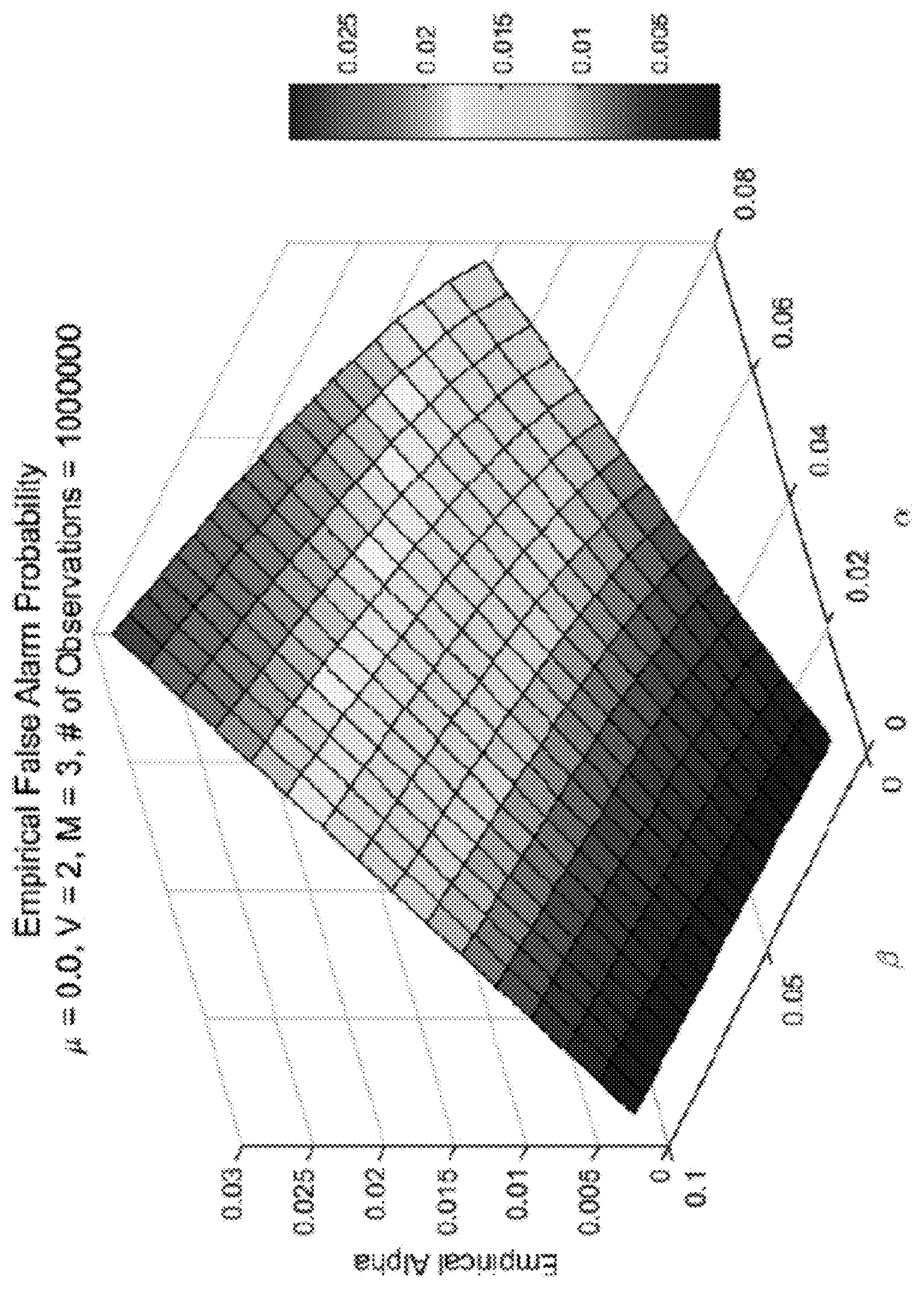

FIG. 5



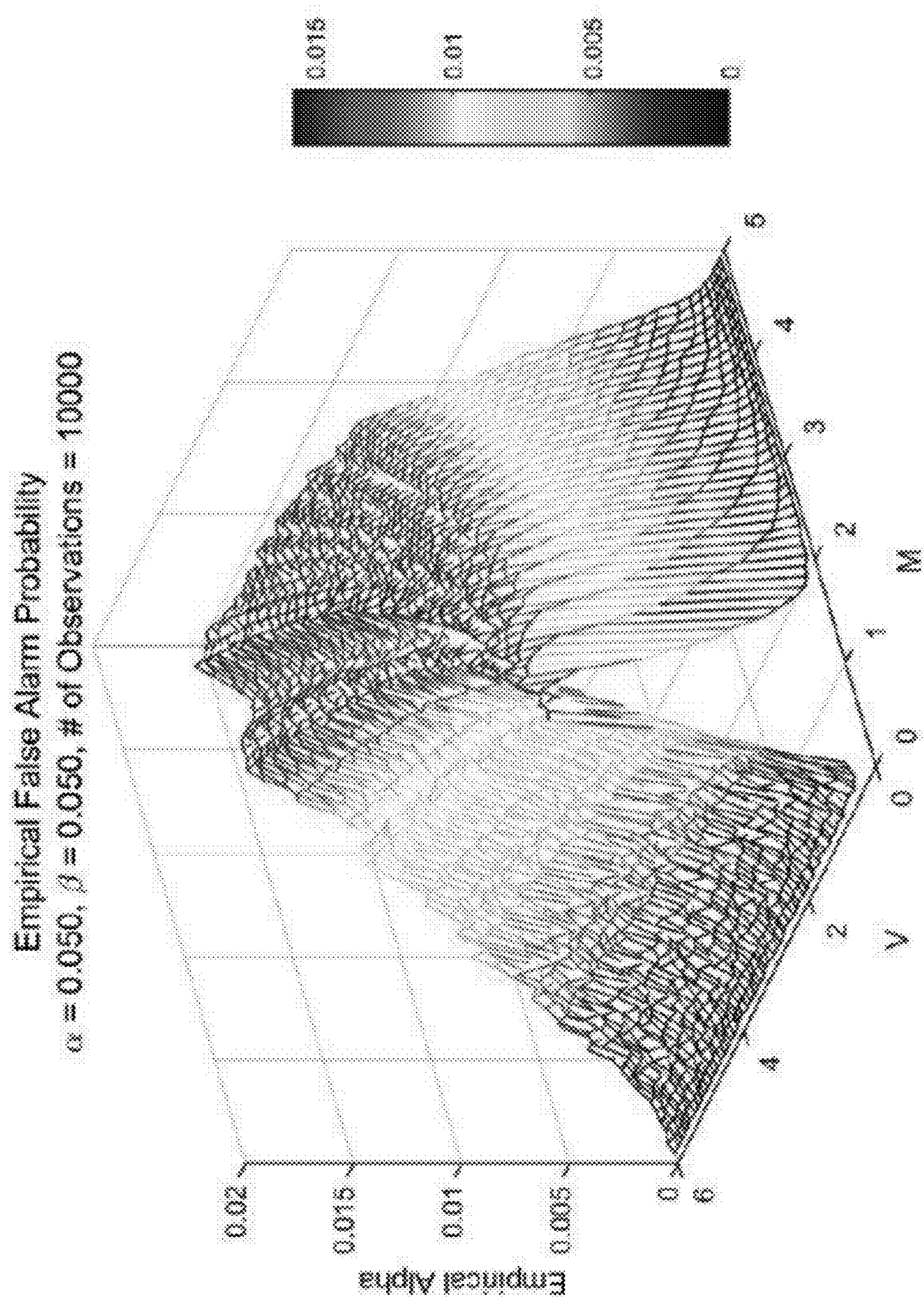

FIG. 6



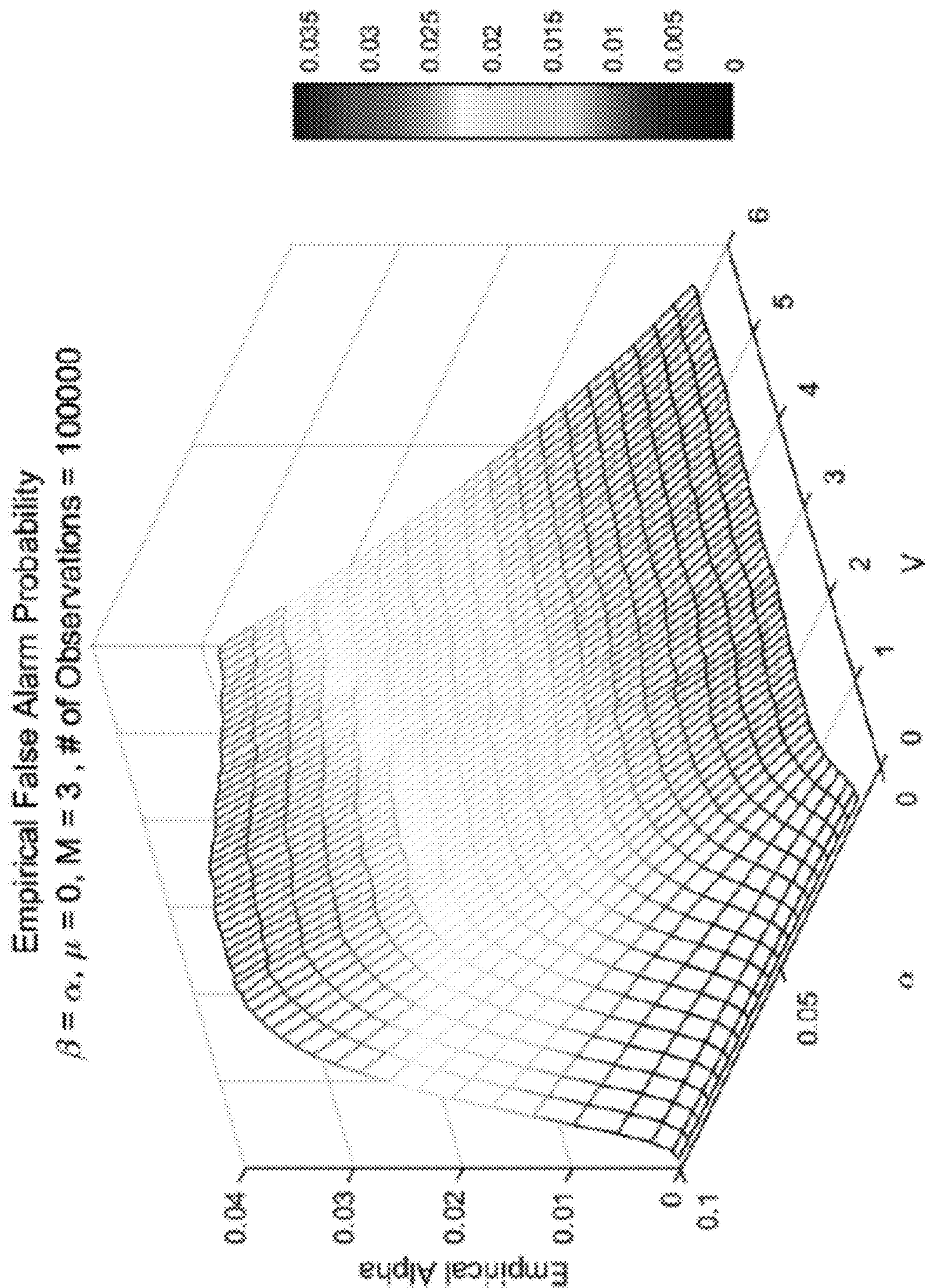

FIG. 7



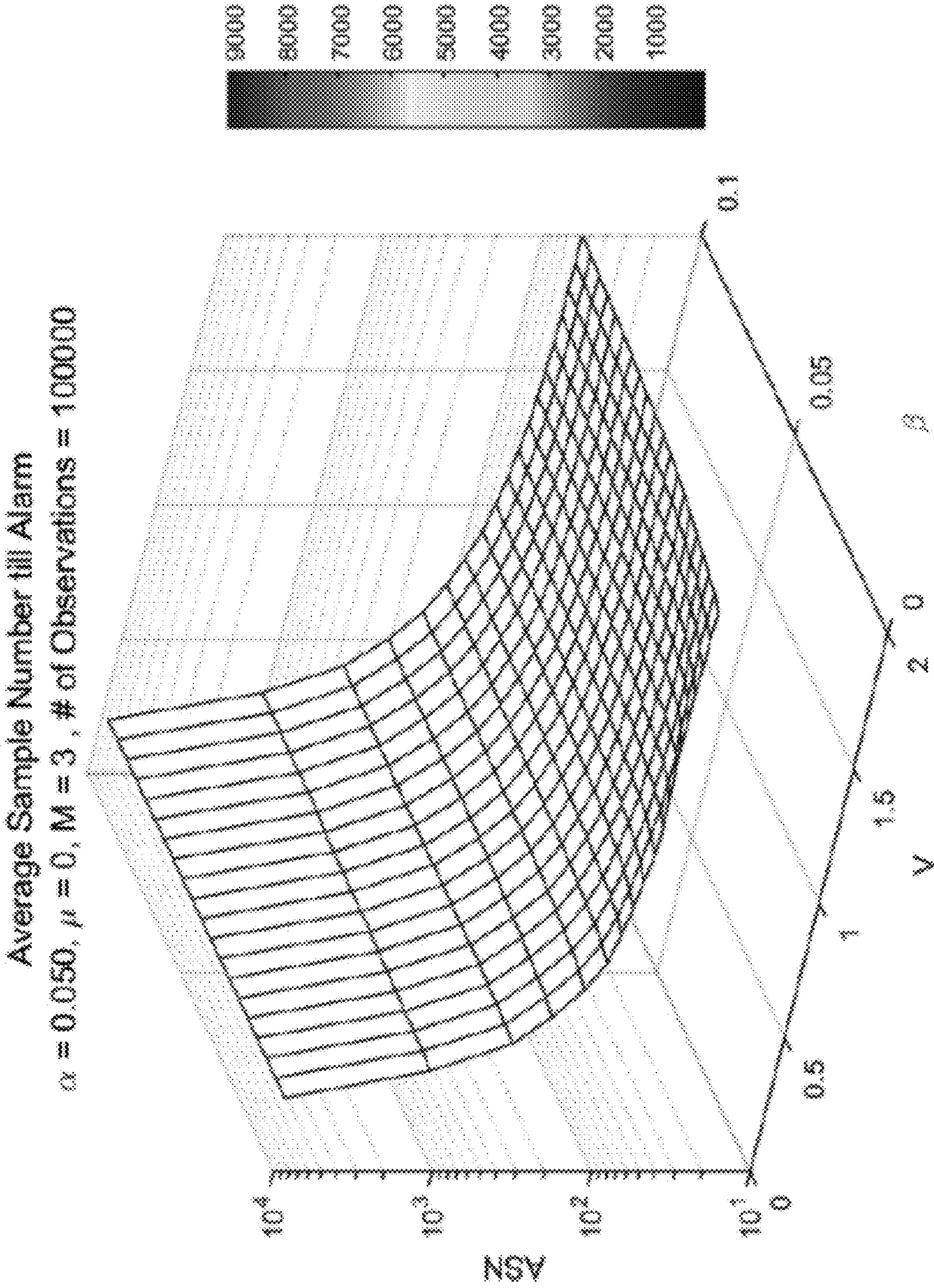

FIG. 8



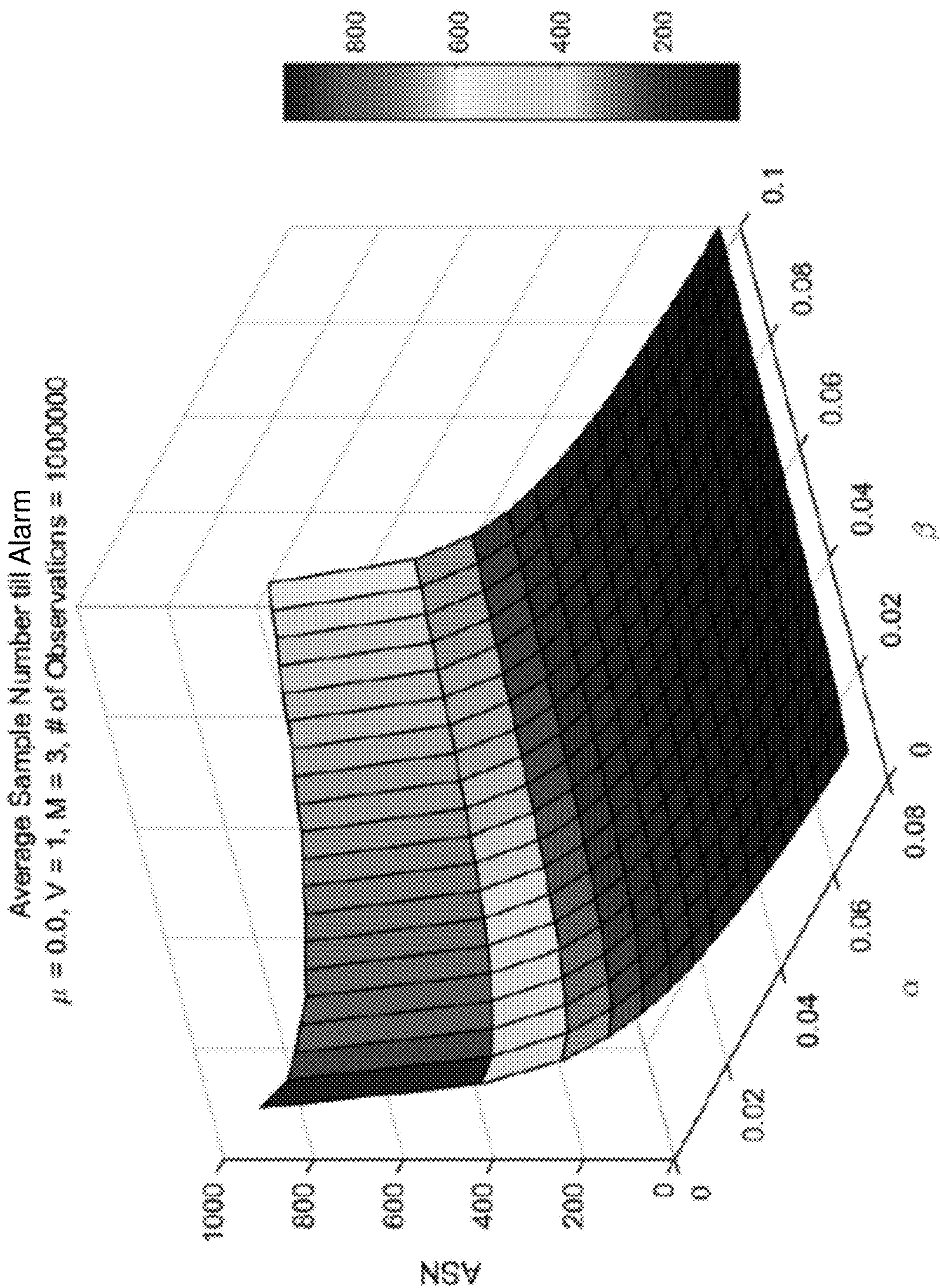

FIG. 9

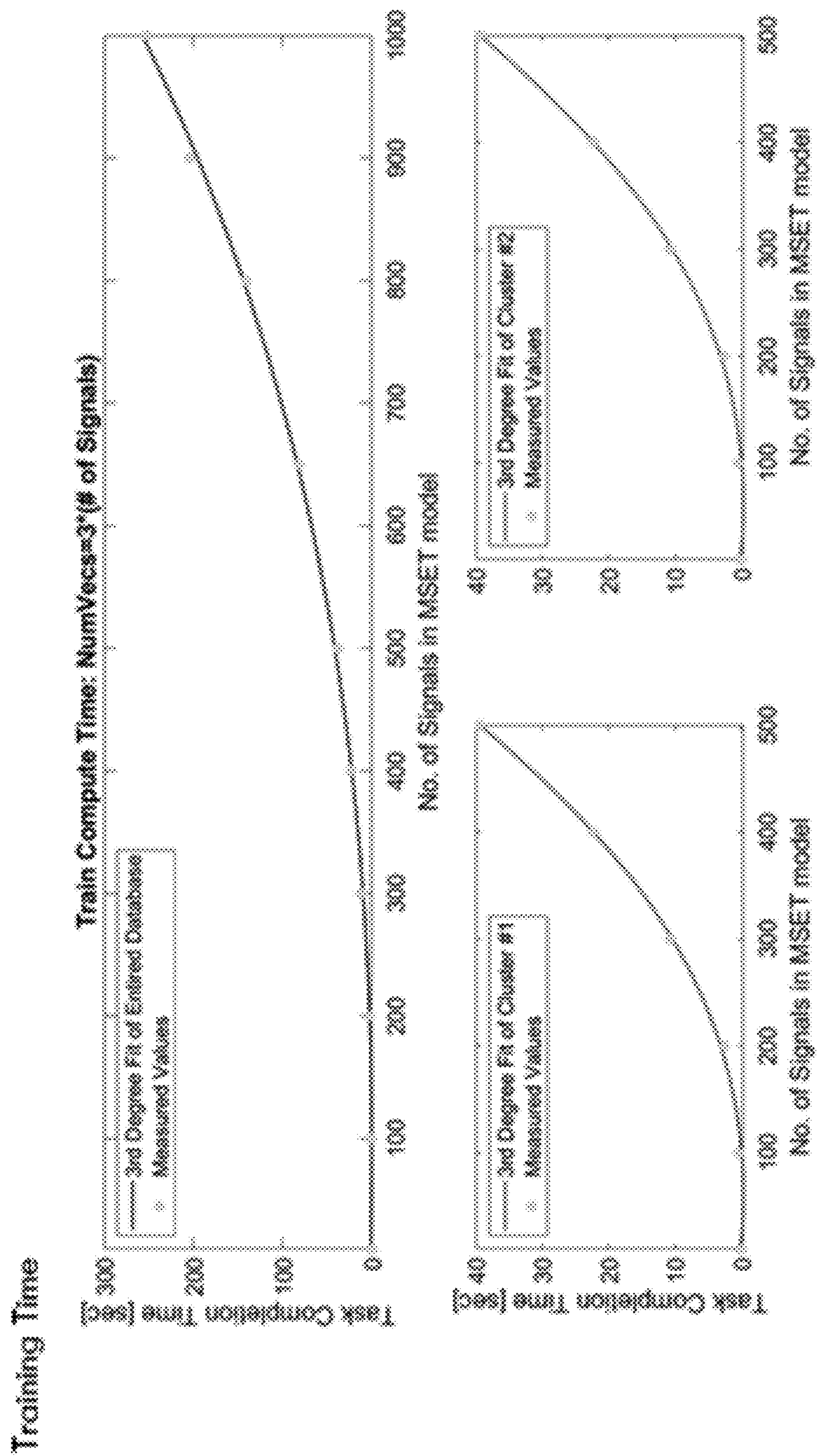

FIG. 10A



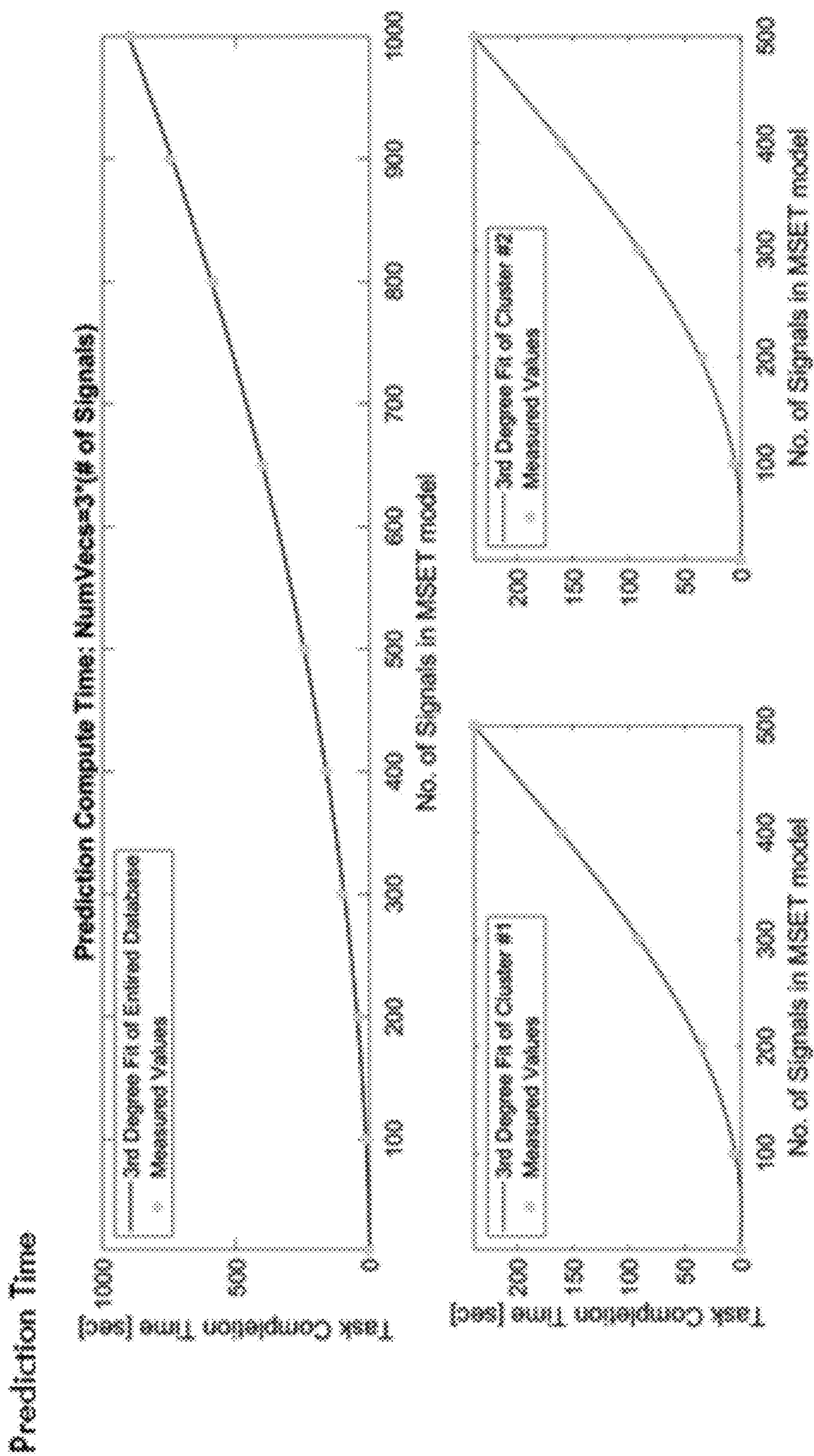
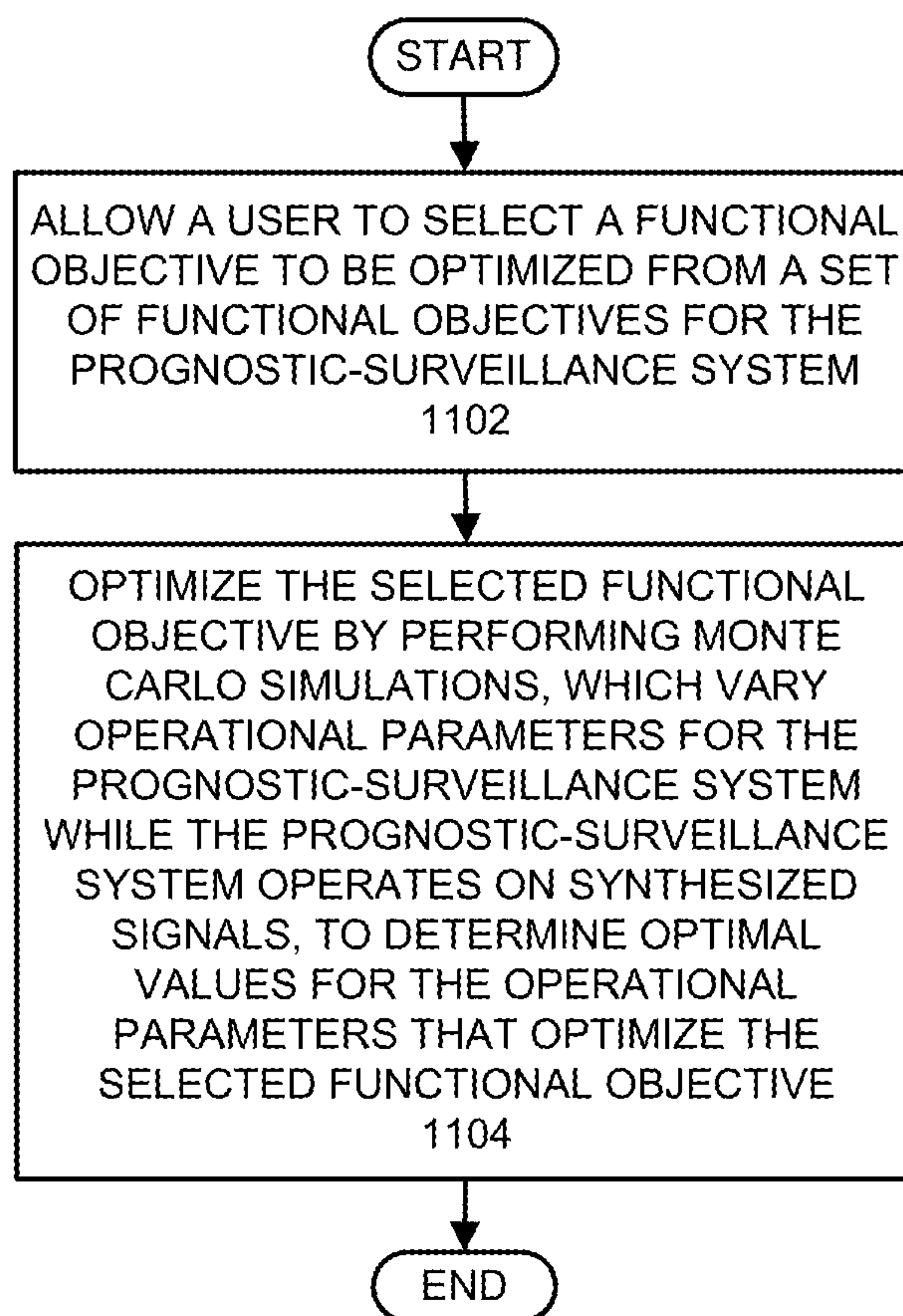

FIG. 10B



**FIG. 11**



**OPTIMIZING A  
PROGNOSTIC-SURVEILLANCE SYSTEM TO  
ACHIEVE A USER-SELECTABLE  
FUNCTIONAL OBJECTIVE**

BACKGROUND

Field

[0001] The disclosed embodiments generally relate to techniques for using machine-learning (ML) models to perform prognostic-surveillance operations based on sensor signals received from a monitored asset. More specifically, the disclosed embodiments relate to a technique for optimizing a prognostic-surveillance system to achieve a user-selectable functional objective.

Related Art

[0002] Large numbers of sensors are presently being deployed to monitor the operational health of critical assets in a large variety of business-critical systems. For example, a medium-sized computer data center can include over 1,000,000 sensors monitoring thousands of servers, a modern passenger jet can include 75,000 sensors, an oil refinery can include over 1,000,000 sensors, and even an ordinary car can have over 100 sensors. These sensors produce large volumes of time-series sensor data, which can be used to perform prognostic-surveillance operations to facilitate detecting incipient anomalies. This makes it possible to take remedial action before the incipient anomalies develop into failures in the monitored assets.

[0003] ML-based prognostic-surveillance techniques typically operate by training an ML model (also referred to as an “inferential model”) to learn correlations among time-series signals. The trained ML model is then placed in a surveillance mode where it is used to predict values for time-series signals based on the correlations with other time-series signals, wherein deviations between actual and predicted values for the time-series signals trigger alarms that indicate an incipient anomaly. This makes it possible to perform remedial actions before the underlying cause of the incipient anomaly leads to a catastrophic failure.

[0004] However, there exist complex tradeoffs among various operational functional objectives that directly affect the effectiveness of a prognostic-surveillance system in specific use cases. In particular, the following three main functional objectives define a “Quality of Information” (QOI) for a prognostic-surveillance system. (1) Fast Anomaly Detection—It is desirable in safety-critical and mission-critical systems to provide early warnings for subtle incipient faults in noisy process signals. An early warning provides more time for a human operator to take appropriate actions to mitigate or avoid costly or dangerous failures, and more time for automated techniques to proactively schedule service actions. (2) High Prognostic Accuracy—It is also desirable for prognostic-surveillance systems to make accurate predictions about whether anomalies exist, wherein this “prognostic accuracy” can be measured in terms of false-alarm probabilities (FAPs) and missed-alarm probabilities (MAPs). (3) Low Compute Cost—In other systems, prognostic accuracy and early anomaly detection are somewhat less important and it is more important to achieve an acceptable compute cost. This is especially critical in large-

scale time-series databases, wherein it is important to reduce memory footprint requirements, caching requirements, and overall compute cost.

[0005] However, researchers have discovered that there exist complex and nonlinear tradeoffs among these three primary QOI objectives. Hence, an inherent challenge (and opportunity) exists in attempting to simultaneously achieve the three functional requirements because they are associated with competing objectives. This means it is impossible to configure a prognostic-surveillance system to optimize all three objectives simultaneously. This is because improving the prognostic-surveillance system to meet any one objective can cause progress toward the other two objectives to decrease. Also, it is rarely the case that a customer desires, needs, or is interested in paying for all three objectives to be achieved for a specific use case.

[0006] Hence, what is needed is technique for optimizing a prognostic-surveillance system to achieve one or more functional objectives for a specific prognostic-surveillance use case.

SUMMARY

[0007] The disclosed embodiments relate to a system that optimizes a prognostic-surveillance system to achieve a user-selectable functional objective. During operation, the system allows a user to select a functional objective to be optimized from a set of functional objectives for the prognostic-surveillance system. Next, the system optimizes the selected functional objective by performing Monte Carlo simulations, which vary operational parameters for the prognostic-surveillance system while the prognostic-surveillance system operates on synthesized signals, to determine optimal values for the operational parameters that optimize the selected functional objective.

[0008] In some embodiments, the set of functional objectives for the prognostic-surveillance system includes: (1) fast anomaly detection, which can be evaluated in terms of an average sample number (ASN) for a detection decision; (2) high prognostic accuracy, which can be evaluated in terms of false alarm probabilities (FAPs) and missed alarm probabilities (MAPs); and (3) low compute cost, which can be evaluated in terms of required computational operations and memory usage.

[0009] In some embodiments, the prognostic-surveillance system uses an inferential model while detecting incipient anomalies, wherein the operational parameters include one or more of the following: a number of signals in the inferential model; a number of samples for each signal; signal-to-noise ratios for the signals; and a number of training vectors for the inferential model.

[0010] In some embodiments, the prognostic-surveillance system uses a sequential probability ratio test (SPRT) while detecting incipient anomalies, wherein the operational parameters include one or more of the following SPRT parameters: a desired false alarm probability parameter  $\alpha$ ; a desired missed alarm probability parameter  $\beta$ ; a variance parameter  $V$ ; and a sensitivity parameter  $M$ .

[0011] In some embodiments, unselected functional objectives in the set of functional objectives become subordinate objectives and/or constraints while performing the Monte Carlo simulations.

[0012] In some embodiments, the system uses a stochastic gradient-descent technique to optimize the selected functional objective while performing Monte Carlo simulations.



**[0013]** In some embodiments, the system performs digital filtering operations on signals received by the prognostic-surveillance system to reduce signal-to-noise ratios of the signals, which improves prognostic accuracy and reduces detection time while increasing compute costs.

**[0014]** In some embodiments, the system performs intelligent data preprocessing operations on signals received by the prognostic-surveillance system to improve signal quality, which improves prognostic accuracy and reduces detection time while increasing compute costs.

**[0015]** In some embodiments, the system configures the prognostic-surveillance system to use the optimal values for the operational parameters during subsequent prognostic-surveillance operations.

#### BRIEF DESCRIPTION OF THE FIGURES

**[0016]** FIG. 1 illustrates an exemplary prognostic-surveillance system in accordance with the disclosed embodiments.

**[0017]** FIG. 2 presents a flow chart illustrating a process for training an inferential model in accordance with the disclosed embodiments.

**[0018]** FIG. 3 presents a flow chart illustrating a process for using an inferential model to perform prognostic-surveillance operations in accordance with the disclosed embodiments.

**[0019]** FIG. 4 presents a block diagram illustrating a process for optimizing objectives for a prognostic-surveillance system in accordance with the disclosed embodiments.

**[0020]** FIG. 5 presents a graph illustrating an empirical alpha as a function of a desired FAP target  $\alpha$  and desired MAP target  $\beta$  for a sequential probability ratio test (SPRT) in accordance with the disclosed embodiments.

**[0021]** FIG. 6 presents a graph illustrating an empirical alpha as a function of a signal variance parameter  $V$  and sensitivity parameter  $M$  for a SPRT in accordance with the disclosed embodiments.

**[0022]** FIG. 7 presents a graph illustrating an empirical alpha as a function of  $\alpha$  and  $V$  in accordance with the disclosed embodiments.

**[0023]** FIG. 8 presents a graph illustrating an average sample number till alarm as a function of  $V$  and  $\beta$  in accordance with the disclosed embodiments.

**[0024]** FIG. 9 presents a graph illustrating an average sample number till alarm as a function of  $\alpha$  and  $\beta$  in accordance with the disclosed embodiments.

**[0025]** FIG. 10A presents graphs illustrating how MSET model-training time varies as a function of the number of signals in the MSET model in accordance with the disclosed embodiments.

**[0026]** FIG. 10B presents graphs illustrating how MSET model-prediction time varies as a function of the number of signals in the MSET model in accordance with the disclosed embodiments.

**[0027]** FIG. 11 presents a flow chart illustrating a process for optimizing a prognostic surveillance system to meet a selected functional objective in accordance with the disclosed embodiments.

#### DETAILED DESCRIPTION

**[0028]** The following description is presented to enable any person skilled in the art to make and use the present embodiments, and is provided in the context of a particular application and its requirements. Various modifications to

the disclosed embodiments will be readily apparent to those skilled in the art, and the general principles defined herein may be applied to other embodiments and applications without departing from the spirit and scope of the present embodiments. Thus, the present embodiments are not limited to the embodiments shown, but are to be accorded the widest scope consistent with the principles and features disclosed herein.

**[0029]** The data structures and code described in this detailed description are typically stored on a computer-readable storage medium, which may be any device or medium that can store code and/or data for use by a computer system. The computer-readable storage medium includes, but is not limited to, volatile memory, non-volatile memory, magnetic and optical storage devices such as disk drives, magnetic tape, CDs (compact discs), DVDs (digital versatile discs or digital video discs), or other media capable of storing computer-readable media now known or later developed.

**[0030]** The methods and processes described in the detailed description section can be embodied as code and/or data, which can be stored in a computer-readable storage medium as described above. When a computer system reads and executes the code and/or data stored on the computer-readable storage medium, the computer system performs the methods and processes embodied as data structures and code and stored within the computer-readable storage medium. Furthermore, the methods and processes described below can be included in hardware modules. For example, the hardware modules can include, but are not limited to, application-specific integrated circuit (ASIC) chips, field-programmable gate arrays (FPGAs), and other programmable-logic devices now known or later developed. When the hardware modules are activated, the hardware modules perform the methods and processes included within the hardware modules.

#### Exemplary Prognostic-Surveillance System

**[0031]** Before describing our technique for optimizing a prognostic-surveillance system further, we first describe an exemplary prognostic-surveillance system that the technique can operate on. FIG. 1 illustrates an exemplary non-adaptive prognostic-surveillance system **100** that accesses a time-series database **106**, containing time-series signals in accordance with the disclosed embodiments. As illustrated in FIG. 1, prognostic-surveillance system **100** operates on a set of time-series sensor signals **104** obtained from sensors in a monitored system **102**. Note that monitored system **102** can generally include any type of machinery or facility, which includes sensors and generates time-series signals. Moreover, time-series signals **104** can originate from any type of sensor, which can be located in a component in monitored system **102**, including: a voltage sensor; a current sensor; a pressure sensor; a rotational speed sensor; and a vibration sensor.

**[0032]** During operation of prognostic-surveillance system **100**, time-series signals **104** can feed into a time-series database **106**, which stores the time-series signals **104** for subsequent analysis. Next, the time-series signals **104** either feed directly from monitored system **102** or from time-series database **106** into a multivariate state estimation technique (MSET) pattern-recognition model **108**. Although it is advantageous to use an inferential model, such as MSET, for pattern-recognition purposes, the disclosed embodiments



can generally use any one of a generic class of pattern-recognition techniques called nonlinear, nonparametric (NLNP) regression, which includes neural networks, support vector machines (SVMs), auto-associative kernel regression (AAKR), and even simple linear regression (LR). [0033] Next, MSET model **108** is “trained” to learn patterns of correlation among all of the time-series signals **104**. This training process involves a one-time, computationally intensive computation, which is performed offline with accumulated data that contains no anomalies. The pattern-recognition system is then placed into a “real-time surveillance mode,” wherein the trained MSET model **108** predicts what each signal should be, based on other correlated variables; these are the “estimated signal values” **110** illustrated in FIG. 1. Next, the system uses a difference module **112** to perform a pairwise differencing operation between the actual signal values and the estimated signal values to produce residuals **114**. The system then performs a “detection operation” on the residuals **114** by using SPRT module **116** to detect anomalies and possibly to generate an alarm **118**. (For a description of the SPRT model, please see Wald, Abraham, June 1945, “Sequential Tests of Statistical Hypotheses.” *Annals of Mathematical Statistics*. 16 (2): 117-186.) In this way, prognostic-surveillance system **100** can proactively alert system operators to incipient anomalies, such as impending failures, hopefully with enough lead time so that such problems can be avoided or proactively fixed.

[0034] The prognostic surveillance system **100** illustrated in FIG. 1 operates generally as follows. During a training mode, which is illustrated in the flow chart in FIG. 2, the system receives a training set comprising time-series signals gathered from sensors in the monitored system under normal fault-free operation (step **202**). Next, the system divides the training data into a training set and a validation set (step **204**). The system then trains the inferential model to predict values of the time-series signals based on the training set, and also tests the inferential model based on the validation set (step **206**). During a subsequent surveillance mode, which is illustrated by the flow chart in FIG. 3, the system receives new time-series signals gathered from sensors in the monitored system (step **302**). Next, the system uses the inferential model to generate estimated values for the set of time-series signals based on the new time-series signals (step **304**). The system then performs a pairwise differencing operation between actual values and the estimated values for the set of time-series signals to produce residuals (step **306**). The system then analyzes the residuals to detect the incipient anomalies in the monitored system. This involves performing a SPRT on the residuals to produce SPRT alarms with associated tripping frequencies (step **308**), and then detecting incipient anomalies based on the tripping frequencies (step **310**). Note that these incipient anomalies can be associated with an impending failure of the monitored system, or a malicious-intrusion event in the monitored system.

#### Overview

[0035] Our new optimization system allows a user to select their most business-critical or mission-critical prognostic-surveillance objective, such as: fast anomaly detection, high prognostic accuracy or low compute cost. The system then optimizes operational parameters for a prognostic-surveillance system to achieve the customer's

selected objective. Note that when one objective is selected, other unselected objectives become the subordinate objectives/constraints during subsequent optimization operations. This ensures that the subordinate objectives will meet or exceed their minimal functional requirements if and when it is possible to do so.

[0036] Our new optimization system uses Monte Carlo simulations to determine how to achieve the objectives. Note that this optimization proceeds empirically (by performing Monte Carlo simulations) because of the stochastic relationships between the functional objectives and the underlying operational parameters of a prognostic-surveillance system, which renders this multi-objective, multi-constraint big-data optimization use case not amenable to conventional closed-form analytical optimization approaches.

[0037] The Monte Carlo simulations use a synthetic data pump, which produces time-series signals that are associated with various permutations of defects in a monitored asset. This synthetic data pump can be used to generate signals that vary operational parameters for the prognostic-surveillance system, including: a number of signals in the inferential model that is used by the prognostic-surveillance system; a number of samples for each signal; signal-to-noise ratios for the signals; and a number of training vectors for the inferential model. The Monte Carlo simulations can be used to answer a number of questions, such as: (1) “what happens if the signal-to-noise ratio in the time-series signals is greater or less?”; (2) “what happens when the sampling rates are greater or less?”; and (3) “what happens if more or fewer training vectors are used to train the inferential model?”. Although these Monte Carlo simulations can require a lot of time, the simulations only need to be performed once for each customer.

[0038] FIG. 4 presents a block diagram illustrating how our new optimization system operates. The system starts with an objective pool **401** that contains a number of objectives, including: (1) high prognostic accuracy **402**; (2) fast anomaly detection **403**; and (3) low compute cost **404**. The system first enables a customer to express a priority preference **405** by selecting a specific functional objective to be optimized. This enables the system to perform an objective and constraint selection operation **406**. During this operation, the system can convert the two unselected functional objectives into subordinate objectives, or alternatively into constraints.

[0039] The system then uses the objectives and constraints to perform an optimization operation **407** based on Monte Carlo simulations, which for example can perform a stochastic (random-walk) gradient descent operation to produce a set of optimal operational parameters **408** for the prognostic-surveillance system. Note that the Monte Carlo simulations can make use of data from a telemetry parameter synthesis system (TPSS) synthesized data pump **409**. (See U.S. patent application Ser. No. 17/334,392, entitled “Signal Synthesizer Data Pump System” by inventors Matthew T. Gerdes, et al., filed on 28 May 2021.)

[0040] These Monte Carlo simulations produce results that can be used to optimize the operational parameters of the prognostic-surveillance system. For example, the graph illustrated in FIG. 5 illustrates how an empirical FAP (empirical alpha) varies as a function of a desired FAP target ( $\alpha$ ) and a desired MAP target ( $\beta$ ). The number of observations in this example is 1,000,000, which is influenced by the



sampling rate. (Note that the prognostic-surveillance system uses a sequential probability ratio test (SPRT) while detecting incipient anomalies, and the operational parameters can include the following SPRT parameters: a desired FAP target  $\alpha$ ; a desired MAP target  $\beta$ ; a mean of the residual  $\mu$ ; a variance parameter  $V$ ; and a sensitivity parameter  $M$ . Also note that these SPRT parameters  $\alpha$ ,  $\beta$ ,  $\mu$ ,  $V$  and  $M$  can be varied during the Monte Carlo simulations.)

**[0041]** As mentioned above, the parameters  $\mu$  and  $V$  are the “mean of the residuals,” and “variance of the residuals” respectively, which are used to identify whether an anomaly may exist. If no anomaly exists (when  $\mu=0$ ), then we do not foresee any false alarms. If a large number of false alarms are produced when no anomalies actually exist, the graph in FIG. 5 can be used to detect this issue. (It means that NumVecs was too small, and needs to be adjusted higher. Or, in one embodiment of the invention, NumVecs is automatically adjusted higher in a small iterative “inner loop” until the empirical false alarms are less than  $a$ ).

**[0042]** In some cases, the Monte Carlo simulations can be used to determine what the empirical false alarm rate actually is for the customer’s signals. For example if a customer has poor-quality sensors and they want to achieve a 2% FAP and a 2% MAP, their data quality may be so bad that it is not feasible to achieve their goal, and this fact will be discovered by the Monte Carlo simulations. We can then tell the customer the desired FAP and MAP cannot be achieved with the present signal quality and/or sampling rate. In another example, a customer may want to be able to detect a developing fault within ten seconds. However, if they have poor-quality signals and a slow sampling rate, they may be prevented from doing so. In this case, we need to tell the customer that the desired detection speed is not possible without better sensors or a higher sampling rate.

**[0043]** FIG. 6 presents a graph that illustrates empirical alpha as a function of the SPRT variance parameter  $V$  and sensitivity parameter  $M$ . If the signal-to-noise ratio (indicated by the variance parameter  $V$ ) is sufficiently poor, for some combinations of  $V$  and  $M$ , we move into a zone on the graph where empirical alpha is unacceptably high. In this case, we can adjust  $M$  and/or  $V$  to move out of the unacceptable zone. For example, we can perform a filtering operation to reduce signal variance, which will reduce empirical alpha. However, this increases compute cost. Note that if the system is outside of the unacceptable zone, we can also optimize the operational parameters for fast anomaly detection and low compute cost. FIG. 7 presents a graph that illustrates empirical alpha as a function of  $\alpha$  and  $V$ , wherein  $\beta=\alpha$ .

**[0044]** FIGS. 8 and 9 are associated with the fast anomaly detection. More specifically, FIG. 8 presents a graph that illustrates the average sample number till alarm (ASN) as a function of  $V$  and  $\beta$ , and FIG. 9 presents a graph that illustrates the ASN as a function of  $\alpha$  and  $\beta$ . In both of these graphs, the ASN metric provides an indicator of how long it takes to detect an anomaly. For example, a customer might want to know within 10 seconds whether an anomaly exists. In portions of the graph where the ASN is below 200, the prognostic-surveillance system is able to make a decision very quickly; this results in an ASN number below 200. By carefully examining these graphs, we can adjust the operational parameters to achieve fast anomaly detection times while simultaneously providing good performance for other subordinate objectives. Also, if it is not possible to achieve

the desired fast detection time, the optimization process will detect this problem. Note that it is important for the customer to be aware of this problem before they actually proceed to implement a prognostic-surveillance system.

**[0045]** FIGS. 10A and 10B present graphs that demonstrate the nonlinear relationship between the number of signals in an MSET model and the corresponding computation time required to train the MSET model (FIG. 10A) and the corresponding computation time required to detect an anomaly (FIG. 10B). As we increase the number of signals, the sampling rate and/or the number of vectors, the compute cost goes up nonlinearly. This means that if we want to improve FAP, we cannot arbitrarily increase the number of signals, the sampling rate or the number of vectors, because the compute cost may become unacceptably high.

**[0046]** Also note that signals are sometimes quantized, and if the resulting quality of the signals is poor, we can use an intelligent data preprocessing (IDP) technique to perform a preprocessing operation to improve the signals that feed into the prognostic-surveillance system. This has a compute cost, but it can significantly reduce FAP and MAP rates and can also reduce ASN. In situations where the signal quality is insufficient to meet the customer’s functional objectives for accuracy and/or fast detection time, the sampling rate is maxed out, and it is too costly to replace the sensors, we can possibly use an IDP technique to improve the signals to meet the functional objectives with a slightly higher compute cost. (For a description of various IDP techniques, please see U.S. Pat. No. 10,740,310, entitled “Intelligent Preprocessing of Multi-Dimensional Time-Series Data” by inventors Dieter Gawlick, et al., filed on 10 Mar. 2018.)

#### Process of Producing Synthetic Signals

**[0047]** FIG. 11 presents a flow chart illustrating a process for optimizing an ML-based prognostic-surveillance system to achieve a user-selectable functional objective in accordance with the disclosed embodiments. During operation, the system allows a user to select a functional objective to be optimized from a set of functional objectives for the prognostic-surveillance system (step 1102). Next, the system optimizes the selected functional objective by performing Monte Carlo simulations, which vary operational parameters for the prognostic-surveillance system while the prognostic-surveillance system operates on synthesized signals, to determine optimal values for the operational parameters that optimize the selected functional objective (step 1104).

**[0048]** Various modifications to the disclosed embodiments will be readily apparent to those skilled in the art, and the general principles defined herein may be applied to other embodiments and applications without departing from the spirit and scope of the present invention. Thus, the present invention is not limited to the embodiments shown, but is to be accorded the widest scope consistent with the principles and features disclosed herein.

**[0049]** The foregoing descriptions of embodiments have been presented for purposes of illustration and description only. They are not intended to be exhaustive or to limit the present description to the forms disclosed. Accordingly, many modifications and variations will be apparent to practitioners skilled in the art. Additionally, the above disclosure is not intended to limit the present description. The scope of the present description is defined by the appended claims.



What is claimed is:

**1.** A method for optimizing a prognostic-surveillance system to achieve a user-selectable functional objective, comprising:

allowing a user to select a functional objective to be optimized from a set of functional objectives for the prognostic-surveillance system; and

optimizing the selected functional objective by performing Monte Carlo simulations, which vary operational parameters for the prognostic-surveillance system while the prognostic-surveillance system operates on synthesized signals, to determine optimal values for the operational parameters that optimize the selected functional objective.

**2.** The method of claim **1**, wherein the set of functional objectives for the prognostic-surveillance system comprises: fast anomaly detection, which can be evaluated in terms of an average sample number (ASN) for a detection decision;

high prognostic accuracy, which can be evaluated in terms of false alarm probabilities (FAPs) and missed alarm probabilities (MAPs); and

low compute cost, which can be evaluated in terms of required computational operations and memory usage.

**3.** The method of claim **1**, wherein the prognostic-surveillance system uses an inferential model while detecting incipient anomalies, and wherein the operational parameters include one or more of the following:

a number of signals in the inferential model;

a number of samples for each signal;

signal-to-noise ratios for the signals; and

a number of training vectors for the inferential model.

**4.** The method of claim **3**, wherein the prognostic-surveillance system uses a sequential probability ratio test (SPRT) while detecting incipient anomalies, and wherein the operational parameters include one or more of the following SPRT parameters:

a desired false alarm probability parameter  $\alpha$ ;

a desired missed alarm probability parameter  $\beta$ ;

a variance parameter  $V$ ; and

a sensitivity parameter  $M$ .

**5.** The method of claim **1**, wherein unselected functional objectives in the set of functional objectives become subordinate objectives and/or constraints while performing the Monte Carlo simulations.

**6.** The method of claim **1**, wherein the method uses a stochastic gradient-descent technique to optimize the selected functional objective while performing the Monte Carlo simulations.

**7.** The method of claim **1**, wherein the method further comprises performing digital filtering operations on signals received by the prognostic-surveillance system to reduce signal-to-noise ratios of the signals, which improves prognostic accuracy and reduces detection time while increasing compute costs.

**8.** The method of claim **1**, wherein the method further comprises performing intelligent data preprocessing operations on signals received by the prognostic-surveillance system to improve signal quality, which improves prognostic accuracy and reduces detection time while increasing compute costs.

**9.** The method of claim **1**, wherein the method further comprises configuring the prognostic-surveillance system to

use the optimal values for the operational parameters during subsequent prognostic-surveillance operations.

**10.** A non-transitory computer-readable storage medium storing instructions that when executed by a computer cause the computer to perform a method for optimizing a prognostic-surveillance system to achieve a user-selectable functional objective, the method comprising:

allowing a user to select a functional objective to be optimized from a set of functional objectives for the prognostic-surveillance system; and

optimizing the selected functional objective by performing Monte Carlo simulations, which vary operational parameters for the prognostic-surveillance system while the prognostic-surveillance system operates on synthesized signals, to determine optimal values for the operational parameters that optimize the selected functional objective.

**11.** The non-transitory computer-readable storage medium of claim **10**, wherein the set of functional objectives for the prognostic-surveillance system comprises:

fast anomaly detection, which can be evaluated in terms of an average sample number (ASN) for a detection decision;

high prognostic accuracy, which can be evaluated in terms of false alarm probabilities (FAPs) and missed alarm probabilities (MAPs); and

low compute cost, which can be evaluated in terms of required computational operations and memory usage.

**12.** The non-transitory computer-readable storage medium of claim **10**, wherein the prognostic-surveillance system uses an inferential model while detecting incipient anomalies, and wherein the operational parameters include one or more of the following:

a number of signals in the inferential model;

a number of samples for each signal;

signal-to-noise ratios for the signals; and

a number of training vectors for the inferential model.

**13.** The non-transitory computer-readable storage medium of claim **12**, wherein the prognostic-surveillance system uses a sequential probability ratio test (SPRT) while detecting incipient anomalies, and wherein the operational parameters include one or more of the following SPRT parameters:

a desired false alarm probability parameter  $\alpha$ ;

a desired missed alarm probability parameter  $\beta$ ;

a variance parameter  $V$ ; and

a sensitivity parameter  $M$ .

**14.** The non-transitory computer-readable storage medium of claim **10**, wherein unselected functional objectives in the set of functional objectives become subordinate objectives and/or constraints while performing the Monte Carlo simulations.

**15.** The non-transitory computer-readable storage medium of claim **10**, wherein the method further comprises performing digital filtering operations on signals received by the prognostic-surveillance system to reduce signal-to-noise ratios of the signals, which improves prognostic accuracy and reduces detection time while increasing compute costs.

**16.** The non-transitory computer-readable storage medium of claim **10**, wherein the method further comprises performing intelligent data preprocessing operations on signals received by the prognostic-surveillance system to improve signal quality, which improves prognostic accuracy and reduces detection time while increasing compute costs.

**17.** A system that optimizes a prognostic-surveillance system to achieve a user-selectable functional objective, comprising:

a computing system with one or more processors and one or more associated memories; and

an optimization mechanism that executes on the computing system, wherein during operation, the optimization mechanism:

allows a user to select a functional objective to be optimized from a set of functional objectives for the prognostic-surveillance system, and

optimizes the selected functional objective by performing Monte Carlo simulations, which vary operational parameters for the prognostic-surveillance system while the prognostic-surveillance system operates on synthesized signals, to determine optimal values for the operational parameters that optimize the selected functional objective.

**18.** The system of claim **17**, wherein the set of functional objectives for the prognostic-surveillance system comprises:

fast anomaly detection, which can be evaluated in terms of an average sample number (ASN) for a detection decision;

high prognostic accuracy, which can be evaluated in terms of false alarm probabilities (FAPs) and missed alarm probabilities (MAPs); and

low compute cost, which can be evaluated in terms of required computational operations and memory usage.

**19.** The system of claim **17**, wherein the prognostic-surveillance system uses an inferential model while detecting incipient anomalies, and wherein the operational parameters include one or more of the following:

a number of signals in the inferential model;

a number of samples for each signal;

signal-to-noise ratios for the signals; and

a number of training vectors for the inferential model.

**20.** The system of claim **1**, wherein the prognostic-surveillance system uses a sequential probability ratio test (SPRT) while detecting incipient anomalies, and wherein the operational parameters include one or more of the following SPRT parameters:

a desired false alarm probability parameter  $\alpha$ ;

a desired missed alarm probability parameter  $\beta$ ;

a variance parameter  $V$ ; and

a sensitivity parameter  $M$ .

\* \* \* \* \*